

NOTICE DE MONTAGE du karpa
Réf. KA 4563 BM

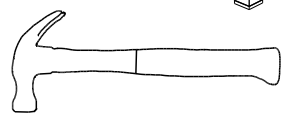

Ø3 mm

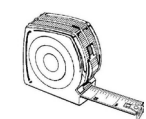
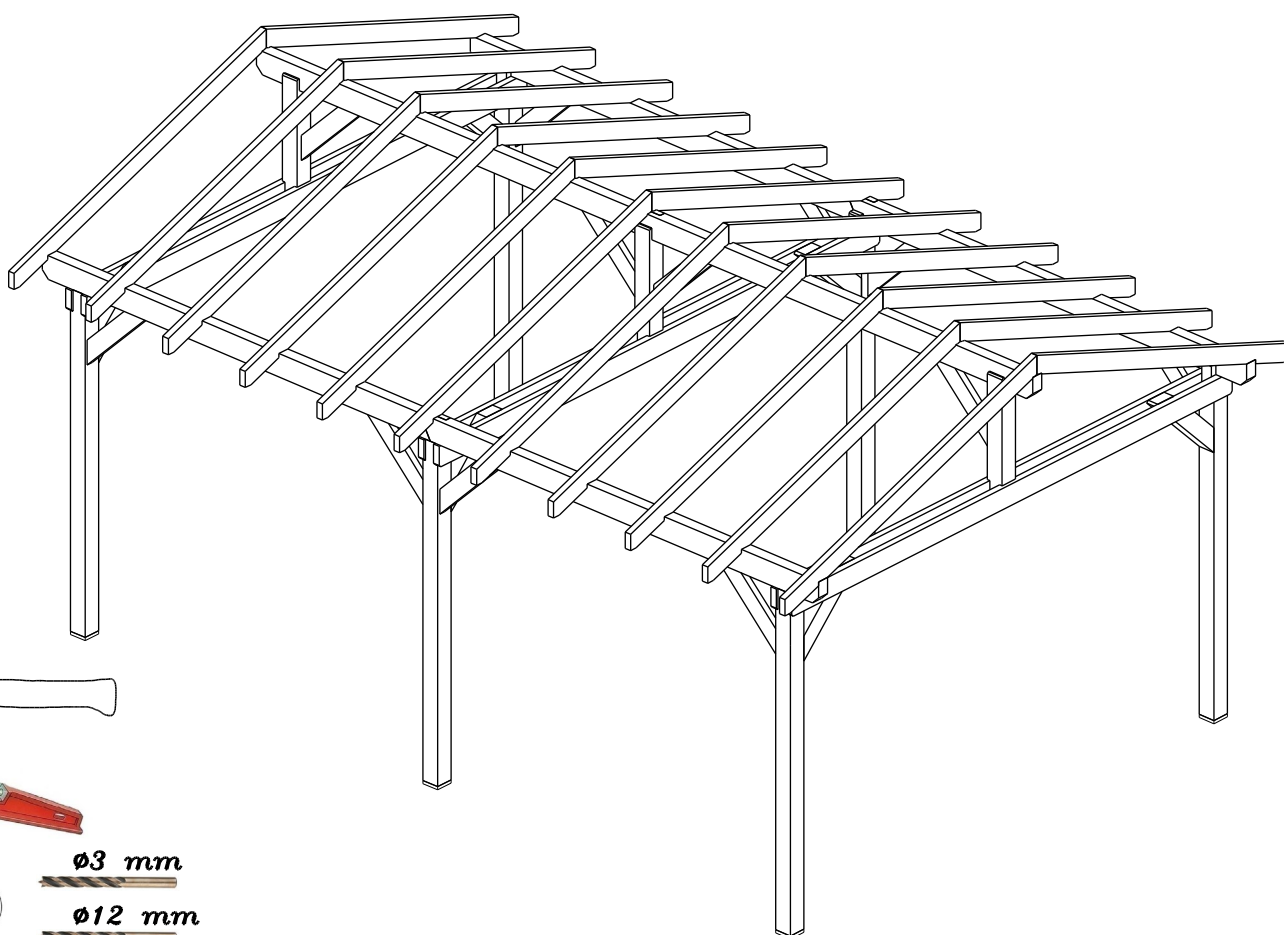
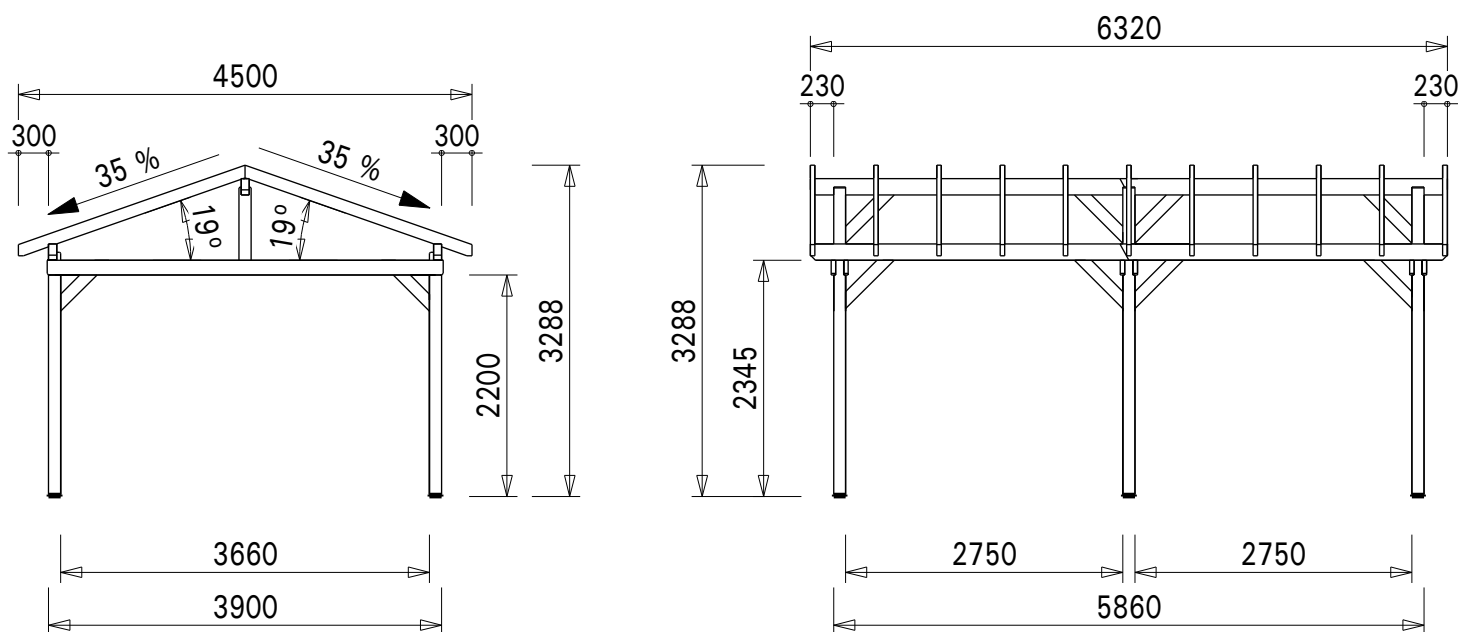

Ø12 mm

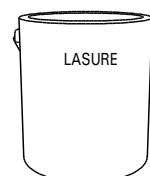
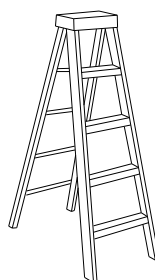
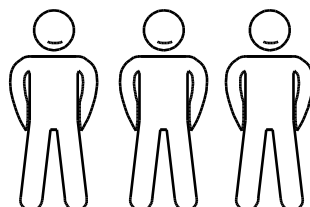
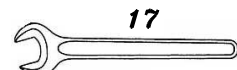

NOTICE DE MONTAGE du karpa
Réf. KA 4563 BM

Vérifier que vous avez bien toutes les pièces avant d'effectuer le montage







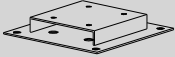

						Demande sav	
Réf.	Qté.	Dessin pièce	Dimensions (en mm)			Observation	Qté.
1	2		120	120	2403		
2	2		120	120	2403		
3	2		120	120	2403		
4	4		80	160	3250		
5	12		45	120	753		
6	6		120	120	736		
7	3		45	145	3930		
8	3		45	145	3930		
9	2		120	120	860		
10	1		120	120	860		
11	2		80	160	3250		
12	22		45	120	2420		

						Demande sav	
v1	108	 (90 mm actif)	15	90	3153		
d1	4		20	120	765		
d2	2		20	120	1700		
d3	2		20	120	3160		

A compléter impérativement pour toute demande SAV et à envoyer par mail à
sav@foresta.fr + photo des pièces abîmées

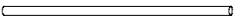
 Colis n°: _____	KA 4563 BM Colis n°: _____	NOM DU MAGASIN (où l'auvent a été acheté)	
		NOM DU CLIENT	
		PRENOM DU CLIENT	
		N° de téléphone	

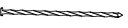
NOTICE DE MONTAGE du karpa
Réf. KA 4563 BM

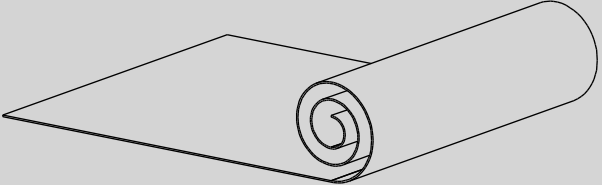
						Demande sav	
Réf.	Qté.	Dessin pièce	Dimensions (en mm)			Observation	Qté.
q1	6		22	160	160		
q2	26			∅ 5	60		
q3	196			∅ 4	40		
q4	18			∅ 5	80		
q5	9			∅ 12	190		
q6	33			∅ 12	150		
q7	11		50	90	50		
q8	44				70		
q9	648				40		
q10	600				16		
q11	4			1.000	10.000		

A compléter impérativement pour toute demande SAV et à envoyer par mail à sav@foresta.fr + photo des pièces abîmées

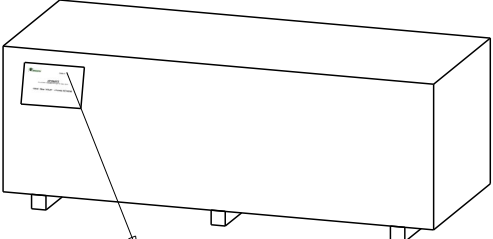
 <p>Colis n°: _____</p>	<p>KA 4563 BM</p> <p>Colis n°: _____</p>	NOM DU MAGASIN (où l'auvent a été acheté)	
		NOM DU CLIENT	
		PRENOM DU CLIENT	
		N° de téléphone	

Plan de soubassement

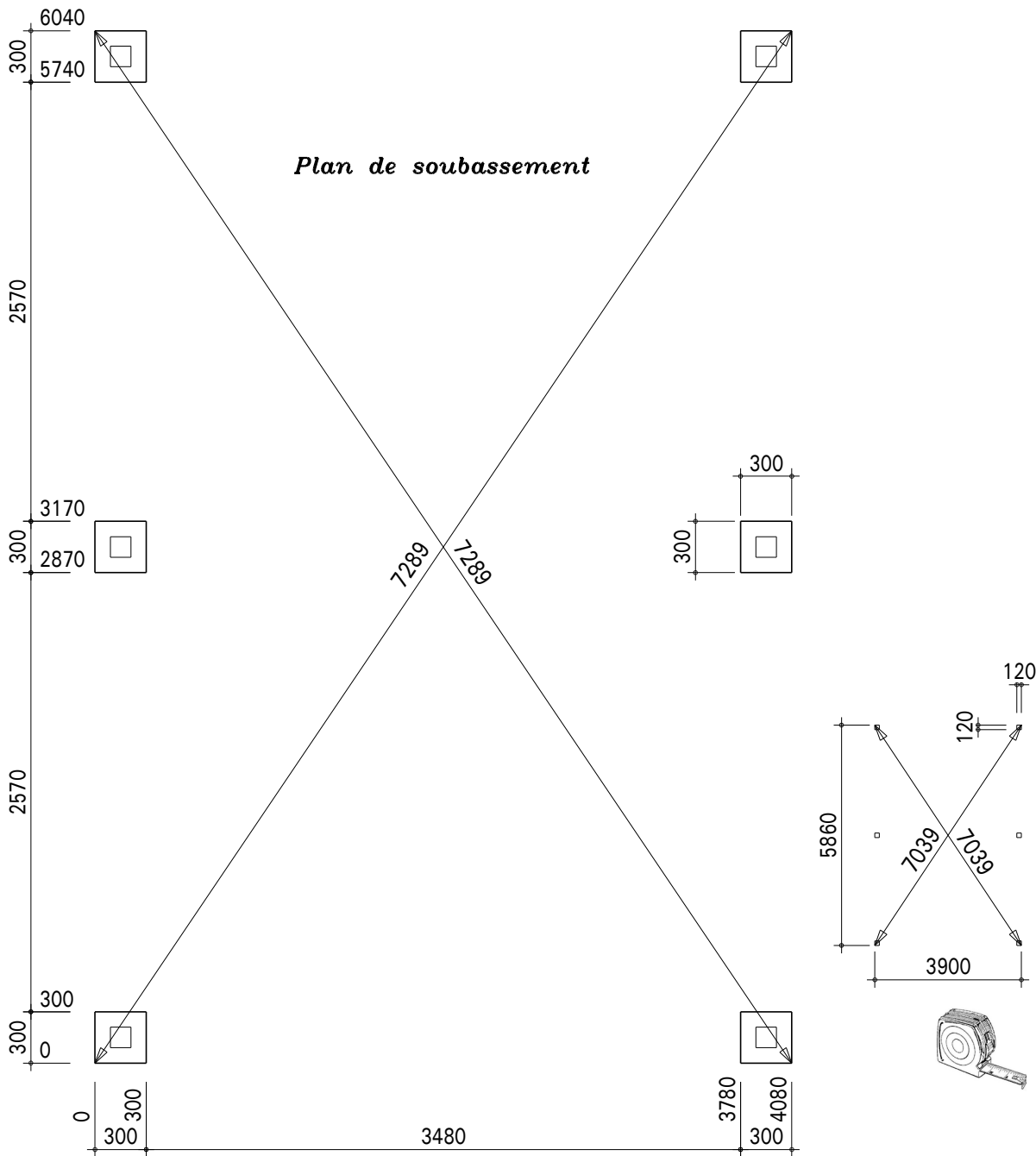

Tolérances à respecter (selon DTU 31.2):

- longueur et largeur: $\pm 0,01\text{m}$;
- équerrage: $\pm 0,01\text{m}$ mesuré sur 10m;
- arase: $\pm 0,01\text{m}$ sur une longueur de 10 mètres linéaires alignés ou non et de $\pm 2\text{mm}$ par mètre linéaire;
- rectitude de bords en plan: $\pm 5\text{mm}$.

MAJ. 27.01.2016

Les dimensions données sur le plan de soubassement sont les dimensions de la dalle béton à réaliser sur un sol parfaitement plat sans aucun autre objet extérieur type mur, clôture ou arbre dans l'entourage de la dalle. Si le produit est implanté près d'un mur, d'une haie ou d'un arbre il est nécessaire de l'éloigner des éléments extérieurs afin de pouvoir facilement le monter et l'entretenir. Nous nous dégageons de toute responsabilité en cas de mauvaise interprétation des dimensions de la dalle.

Le dimensioni del piano di base sono le dimensioni della soletta di cemento da realizzare su un terreno perfettamente piatto, senza alcun altro oggetto esterno, come un muro, una recinzione o un albero in prossimità della soletta. Se il prodotto è installato vicino ad una parete, un recinto o un albero, è necessario distanziarlo adeguatamente, in modo da poterlo facilmente montare e farne la manutenzione. Non ci assumiamo alcuna responsabilità per l'errata interpretazione delle dimensioni della lastra.

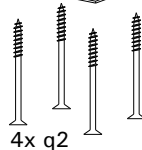
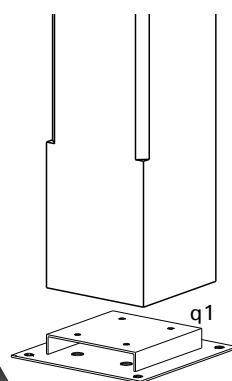
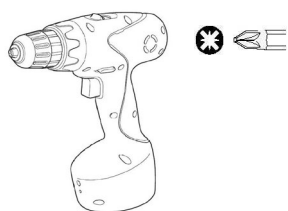
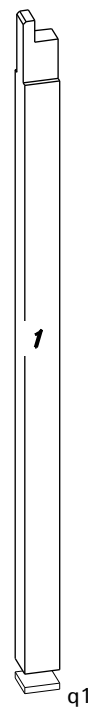
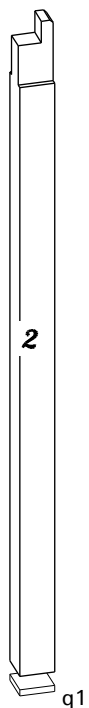
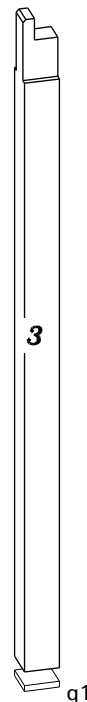
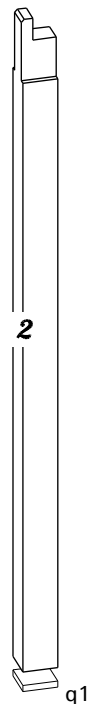
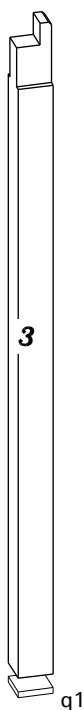
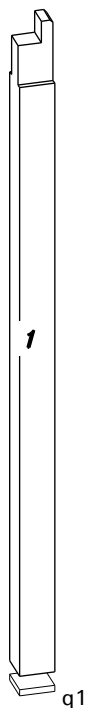

Rep.	Qty.	Dim. (mm)		
1	2	120	120	2403
2	2	120	120	2403
3	2	120	120	2403

Rep.	Qty.	Dim. (mm)		
q1	6	22	160	160
q2	24		∅ 5	60

NOTICE DE MONTAGE du karpa

Réf. KA 4563 BM

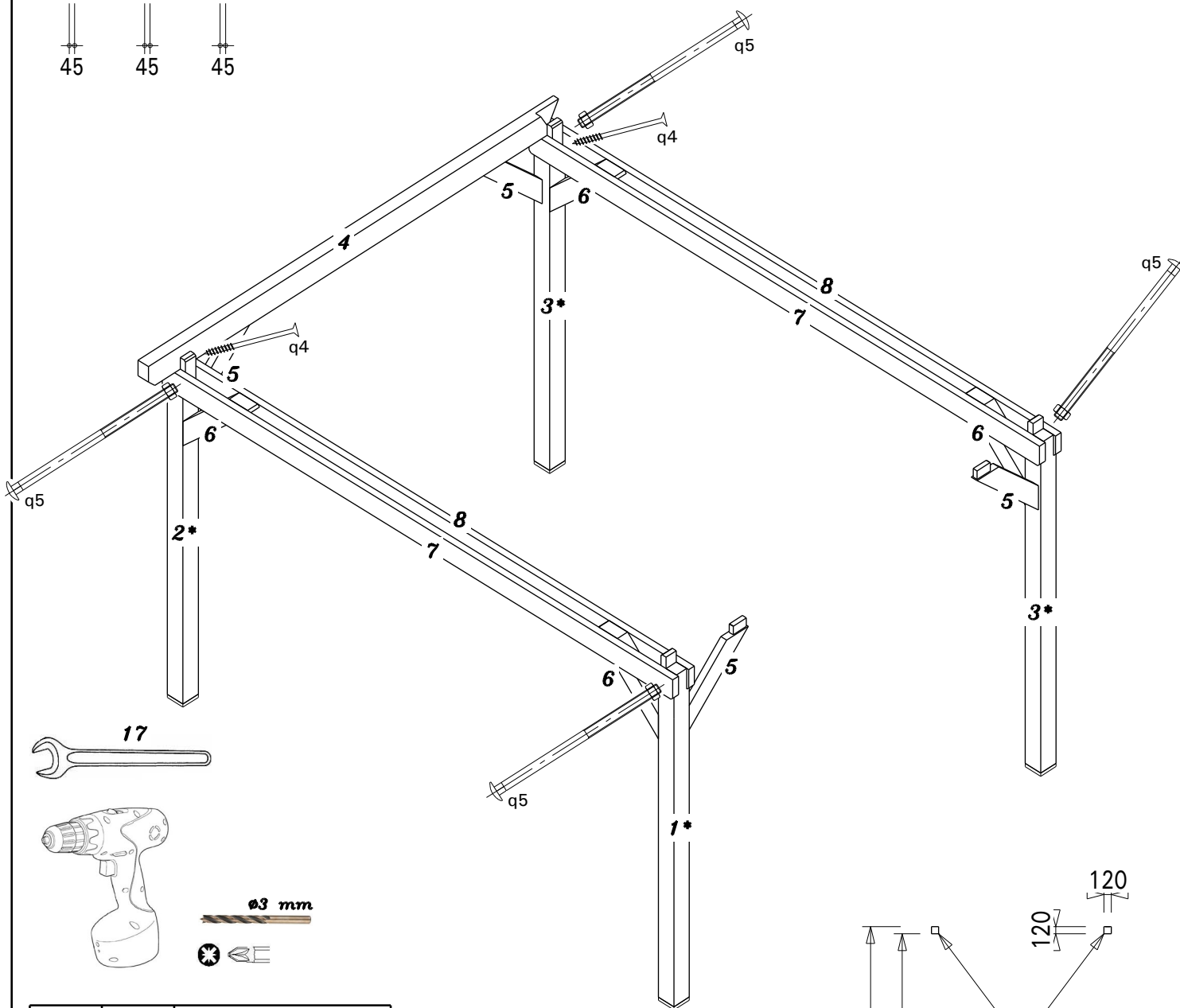
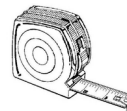
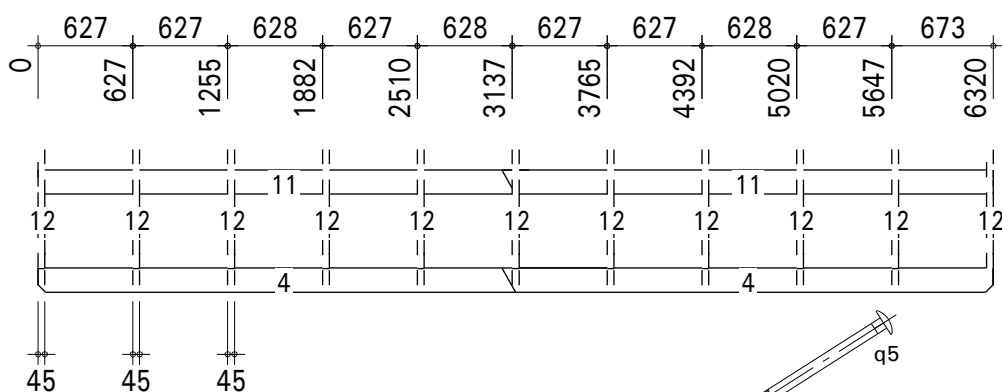

Rep.	Qty.	Dim. (mm)		
4	1	80	160	3250
5	4	45	120	753
6	4	120	120	736
7	2	45	145	3930
8	2	45	145	3930

Rep.	Qty.	Dim. (mm)		
q4	2		∅ 5	80
q5	4		∅ 12	190

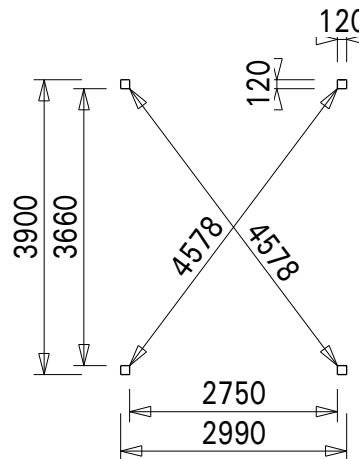

NOTICE DE MONTAGE du karpa
Réf. KA 4563 BM

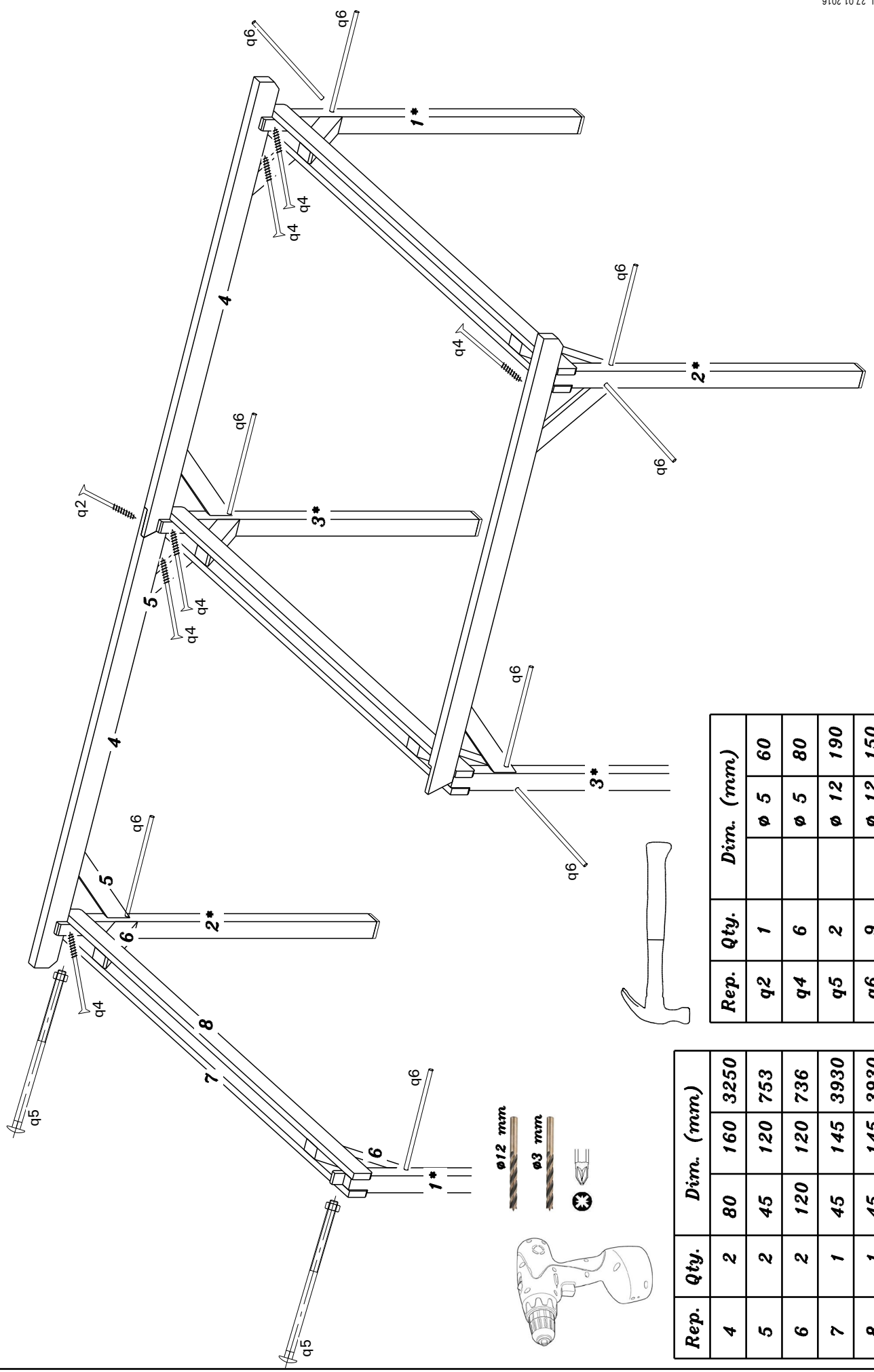

Rep.	Qty.	Dim. (mm)	
4	2	80	3250
5	2	45	753
6	2	120	736
7	1	45	3930
8	1	45	3930

Rep.	Qty.	Dim. (mm)	
q2	1	ø 5	60
q4	6	ø 5	80
q5	2	ø 12	190
q6	9	ø 12	150

NOTICE DE MONTAGE du karpa
Réf. KA 4563 BM

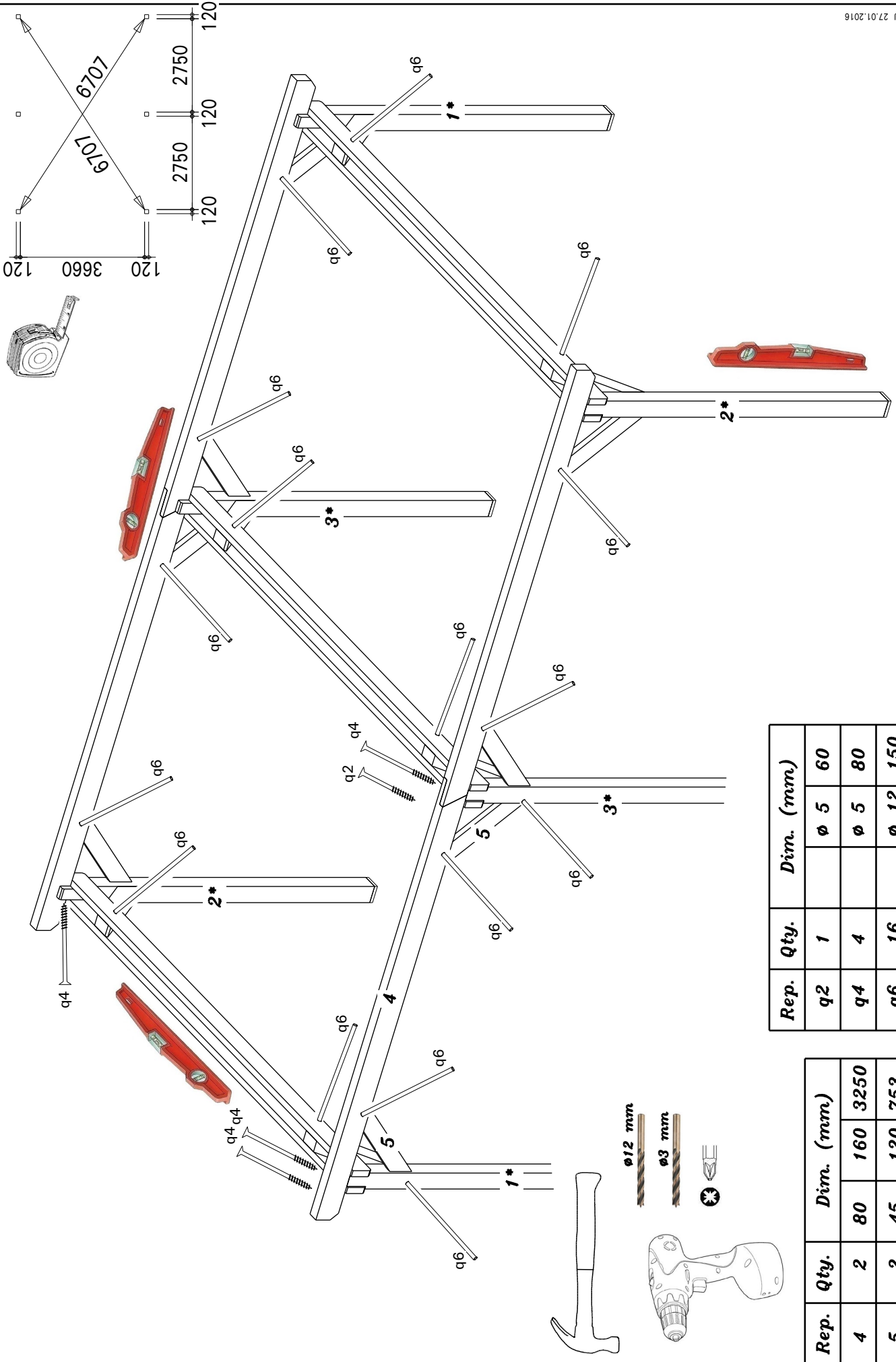

Rep.	Qty.	Dim. (mm)
q2	1	∅ 5 60
q4	4	∅ 5 80
q6	16	∅ 12 150

Rep.	Qty.	Dim. (mm)
4	2	80 160 3250
5	2	45 120 753

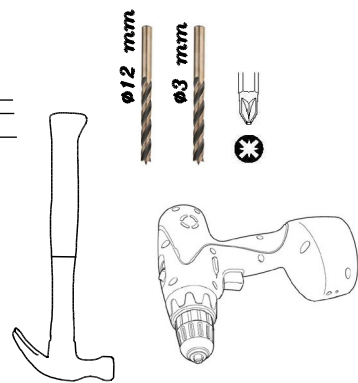

NOTICE DE MONTAGE du karpa
Réf. KA 4563 BM

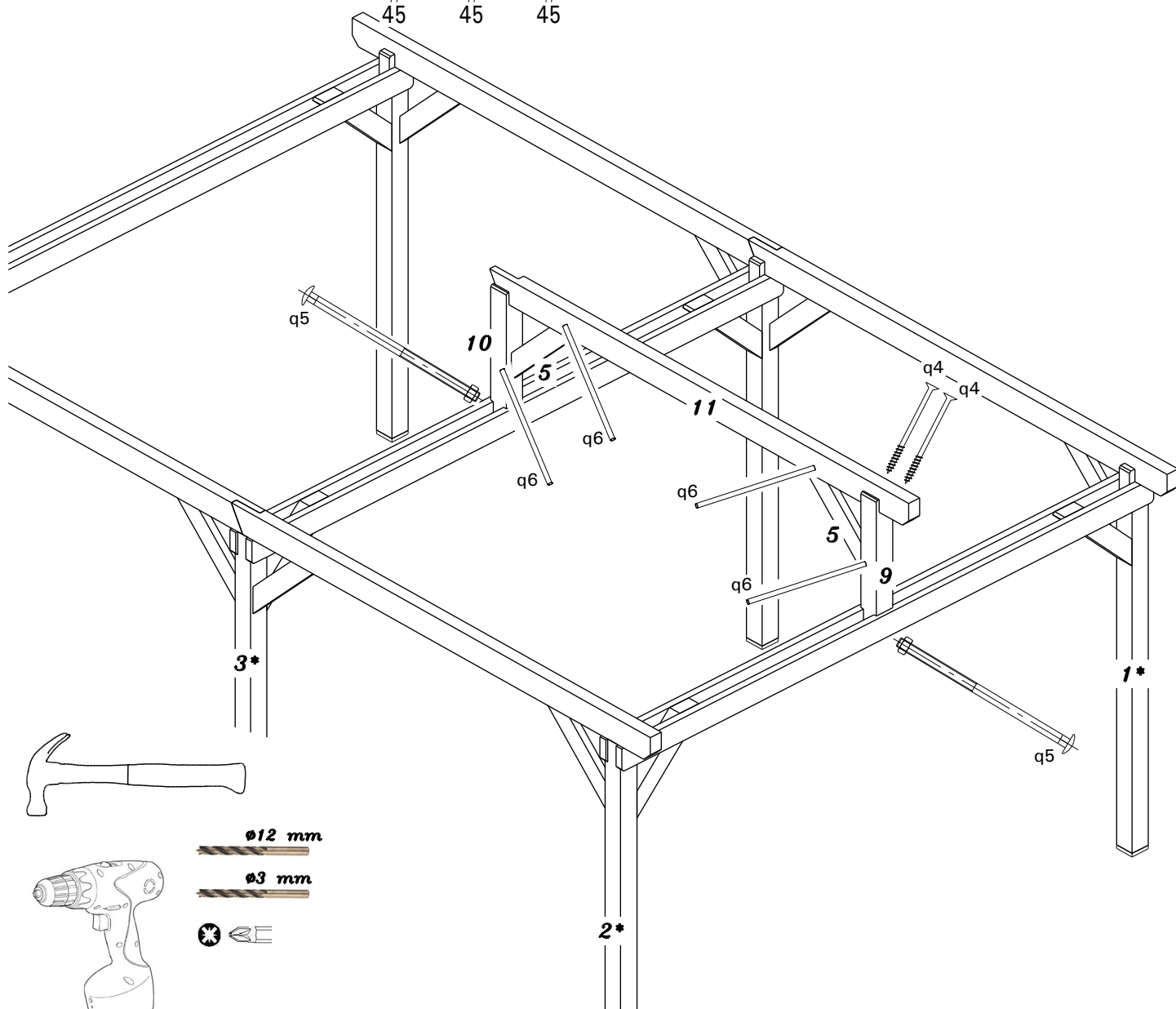
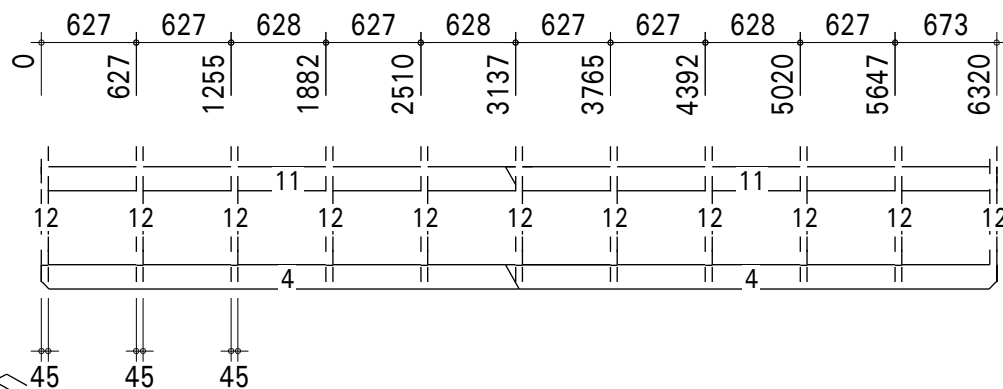

Rep.	Qty.	Dim. (mm)		
5	2	45	120	753
9	1	120	120	861
10	1	120	120	861
11	1	80	160	3250

Rep.	Qty.	Dim. (mm)		
q4	2	$\varnothing 5$		80
q5	2	$\varnothing 12$		190
q6	4	$\varnothing 12$		150

NOTICE DE MONTAGE du karpa
Réf. KA 4563 BM

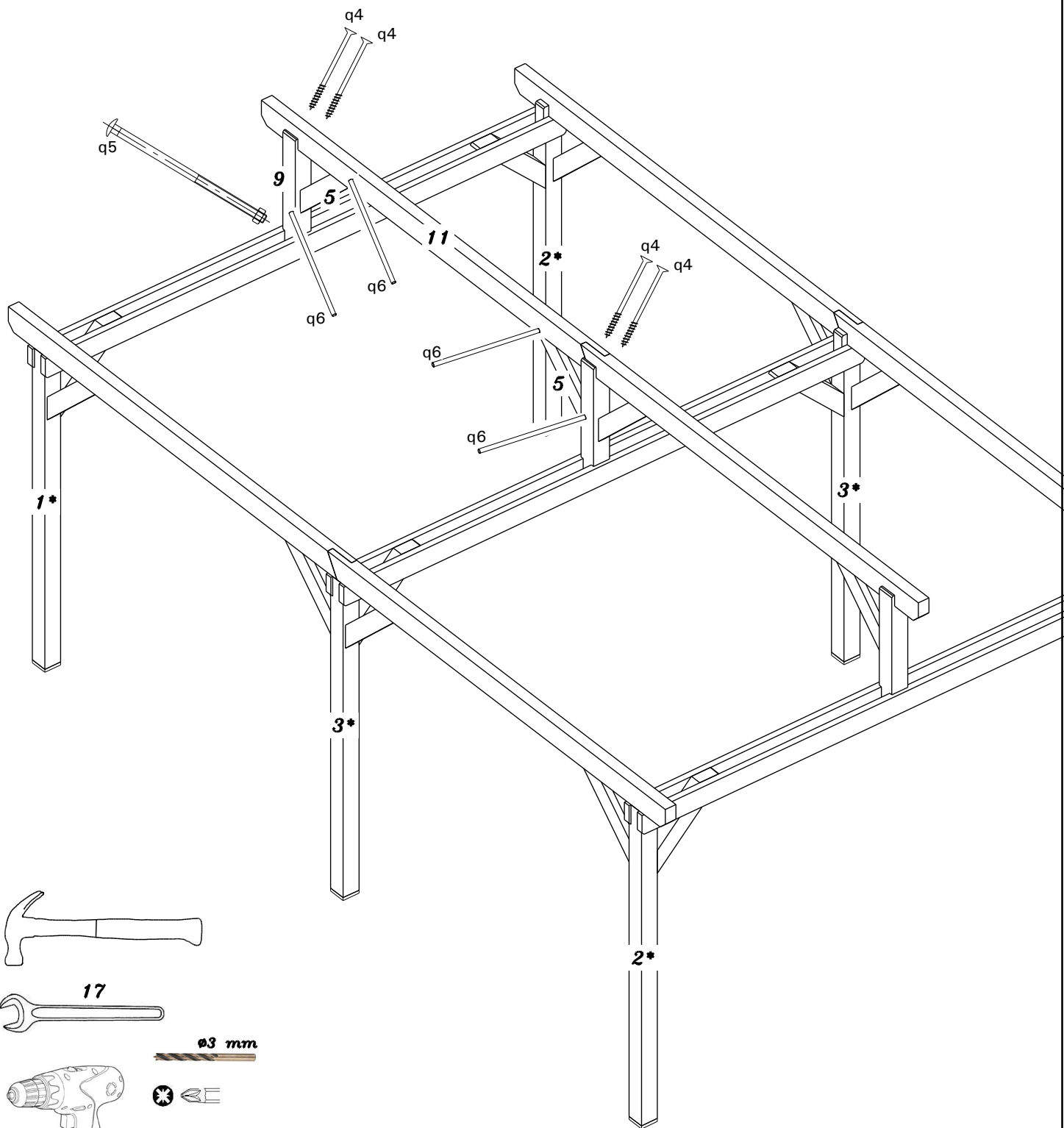

Rep.	Qty.	Dim. (mm)		
5	2	45	120	753
9	1	120	120	861
11	1	80	160	3250

Rep.	Qty.	Dim. (mm)		
q4	4	∅ 5	80	
q5	1	∅ 12	190	
q6	4	∅ 12	150	

NOTICE DE MONTAGE du karpa
Réf. KA 4563 BM

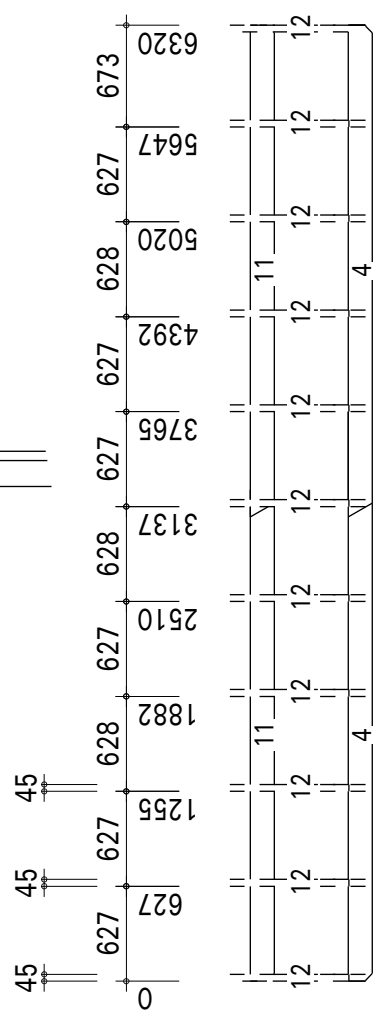
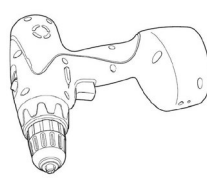
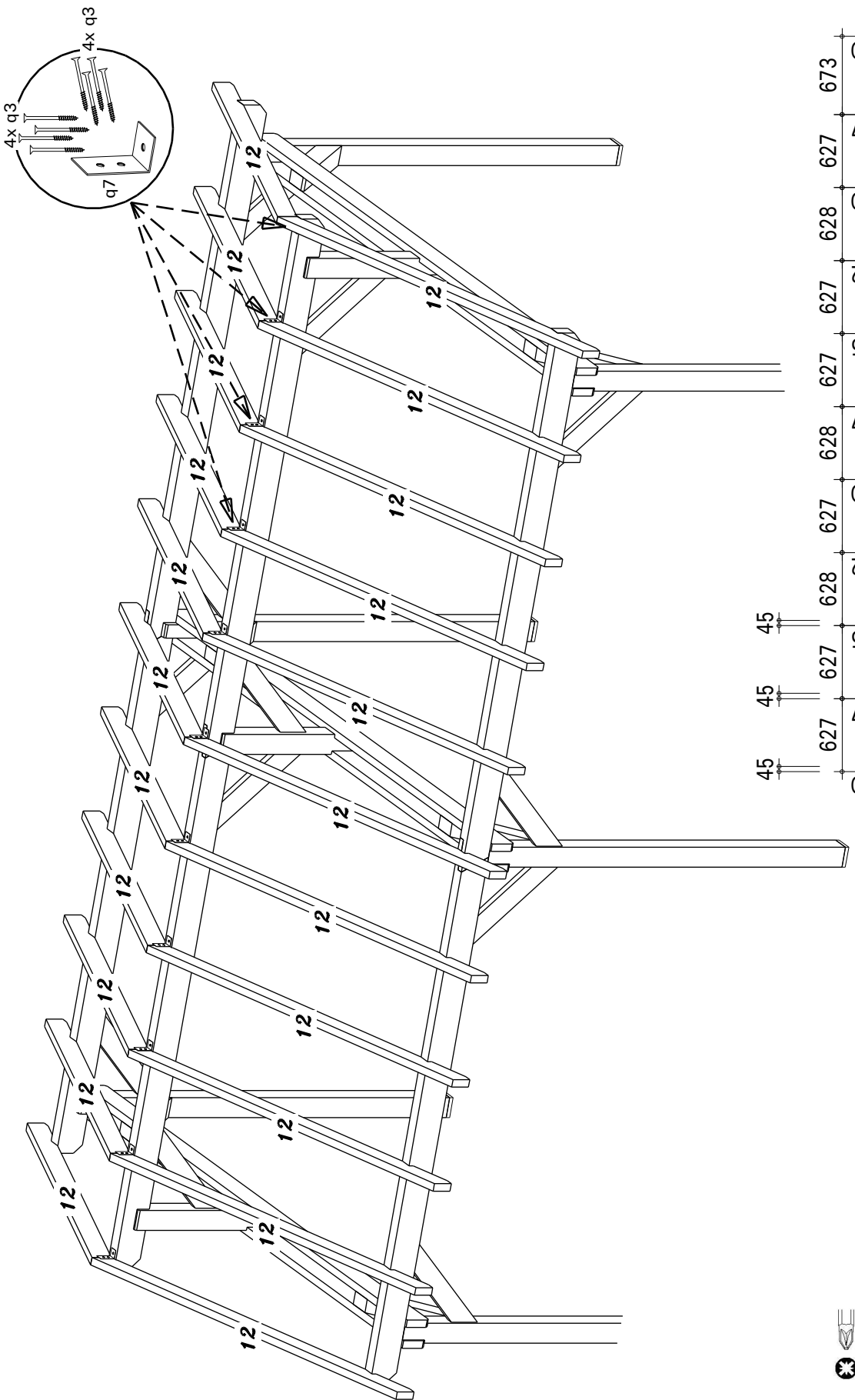

Rep.	Qty.	Dim. (mm)
q3	88	∅ 4 40
q7	11	50 90 50

Rep.	Qty.	Dim. (mm)
12	22	45 120 2420

NOTICE DE MONTAGE du karpa
Réf. KA 4563 BM

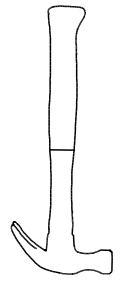
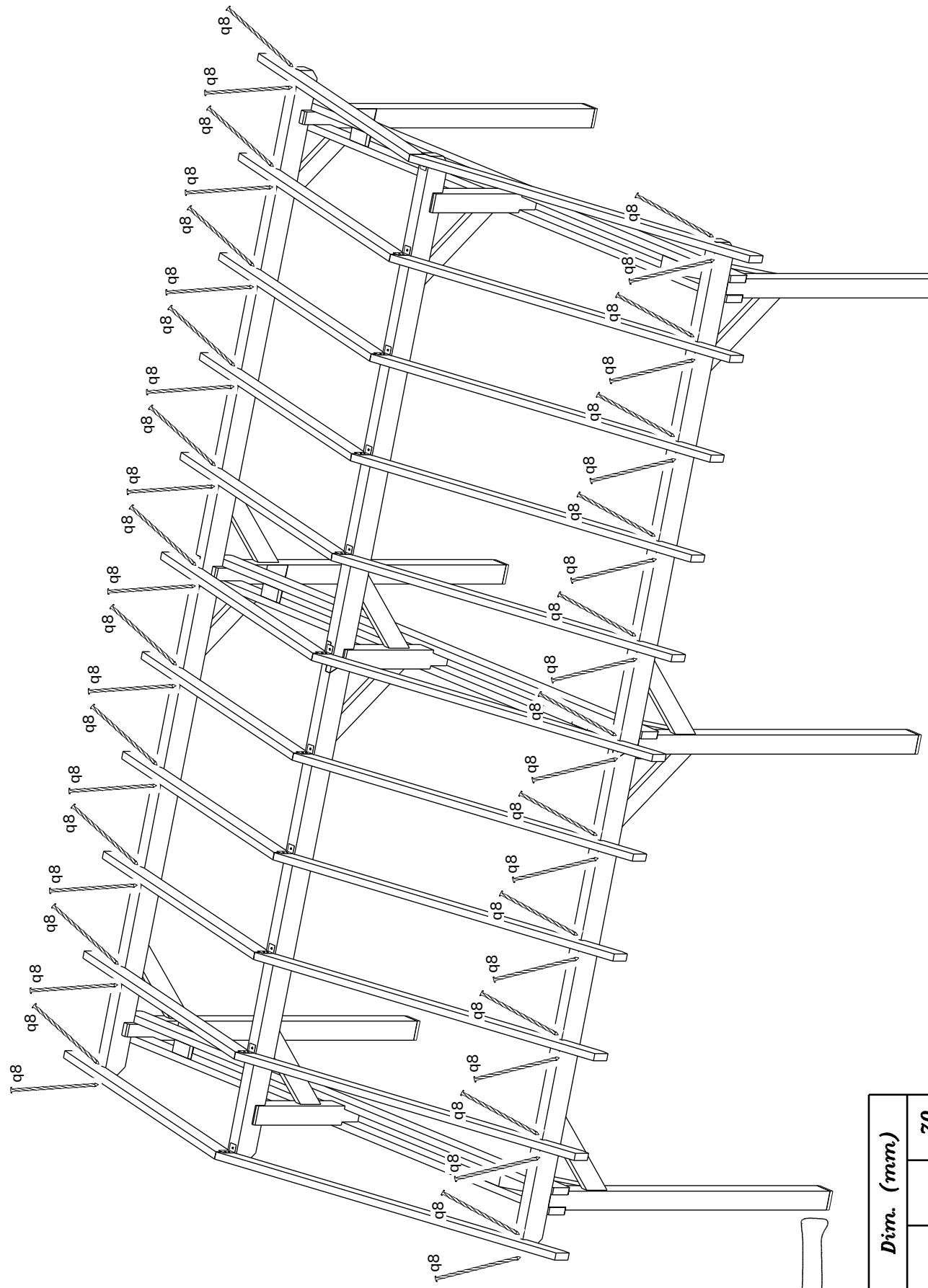

Rep.	Qty.	Dim. (mm)
q8	44	70

NOTICE DE MONTAGE du karpa
Réf. KA 4563 BM

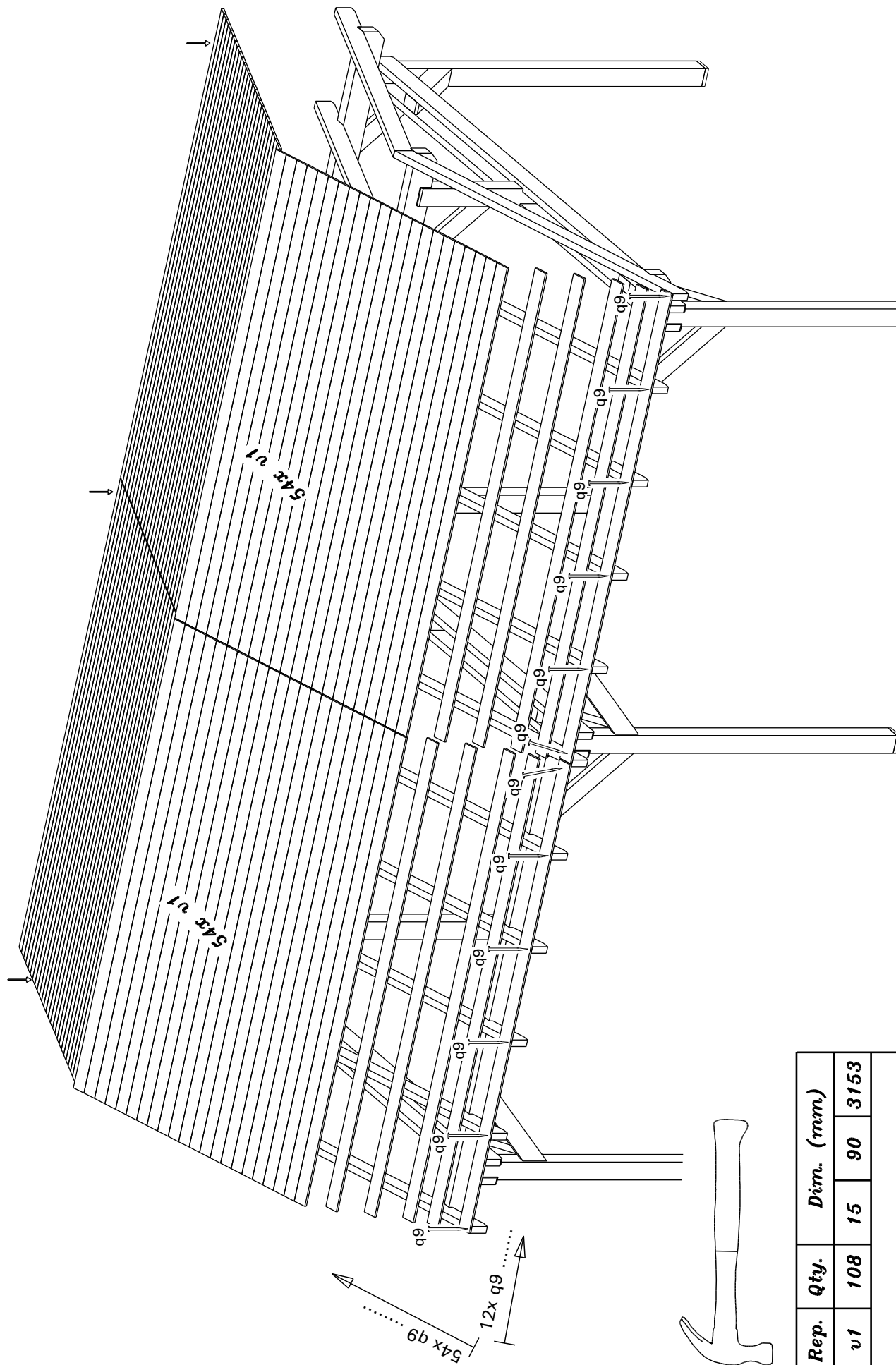

Rep.	Qty.	Dim. (mm)	
v1	108	15	90
q9	648		40

NOTICE DE MONTAGE du karpa
Réf. KA 4563 BM

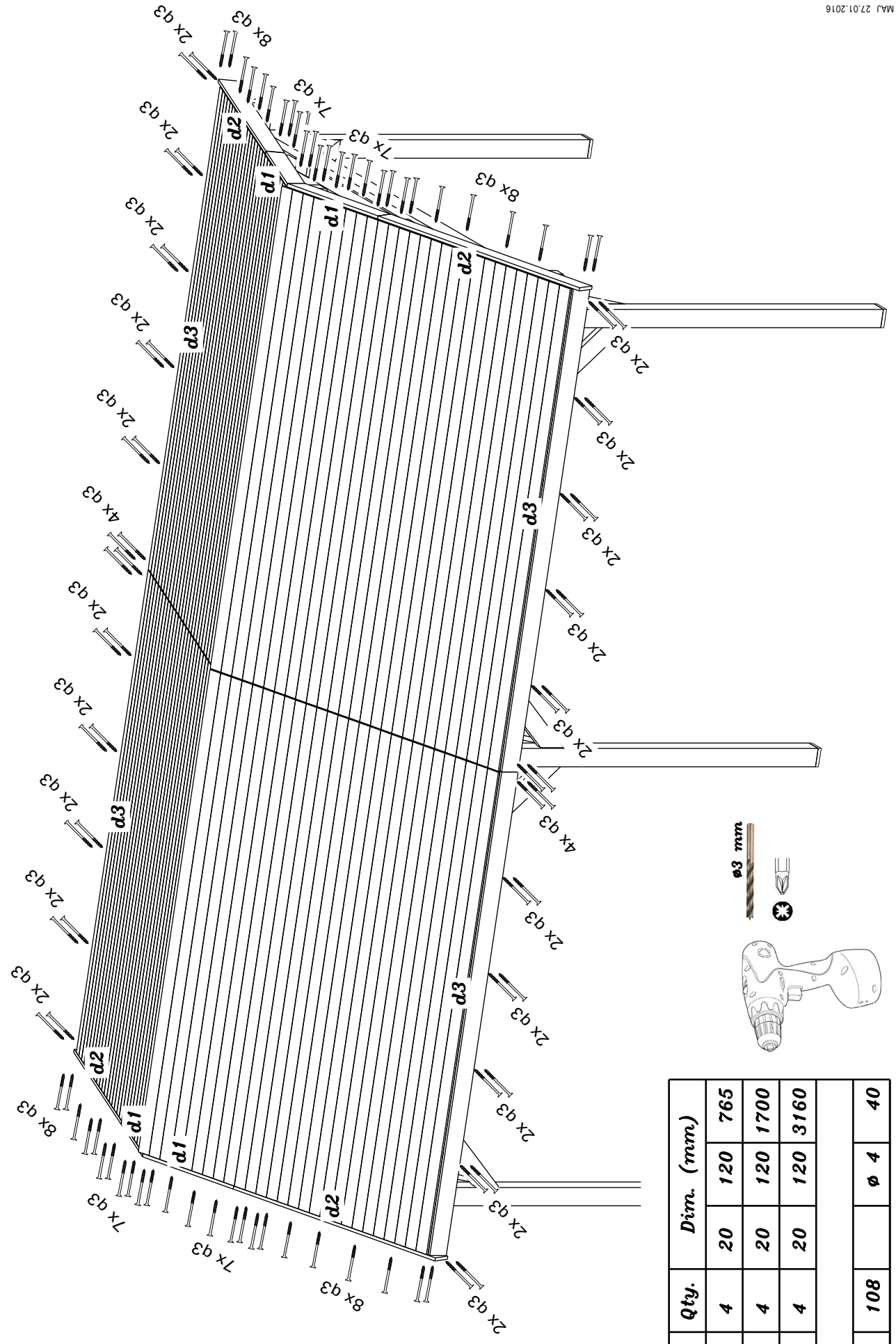

Rep.	Qty.	Dim. (mm)
d1	4	20 120 765
d2	4	20 120 1700
d3	4	20 120 3160
q3	108	ø 4 40

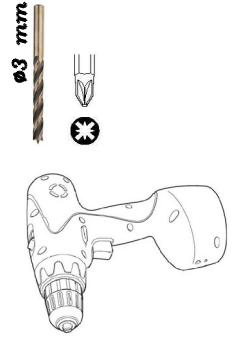

NOTICE DE MONTAGE du karpa
Réf. KA 4563 BM

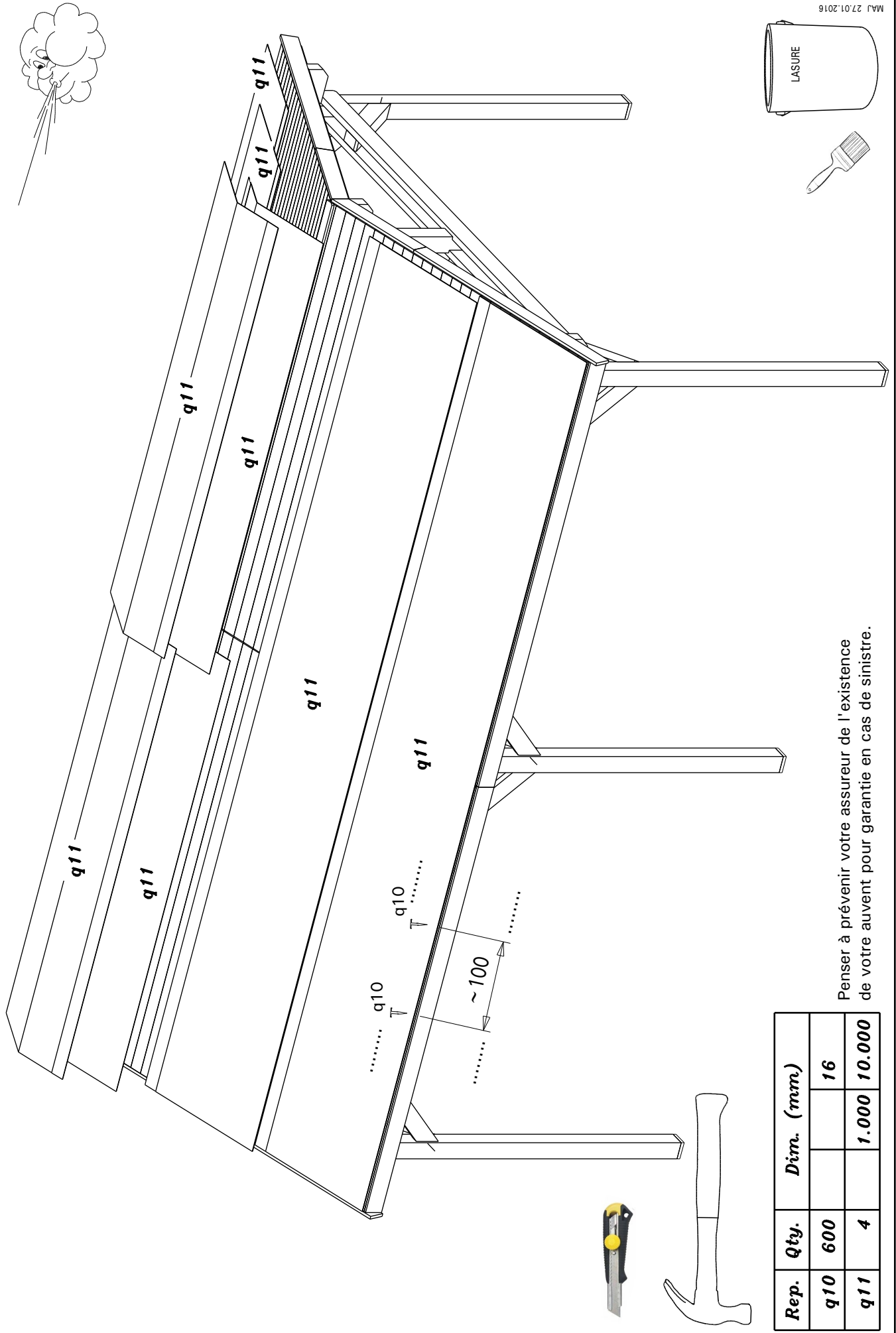

Rep.	Qty.	Dim. (mm.)
q10	600	16
q11	4	1.000 10.000

Penser à prévenir votre assureur de l'existence de votre auvent pour garantie en cas de sinistre.